

# ORCA-D<sup>®</sup>2

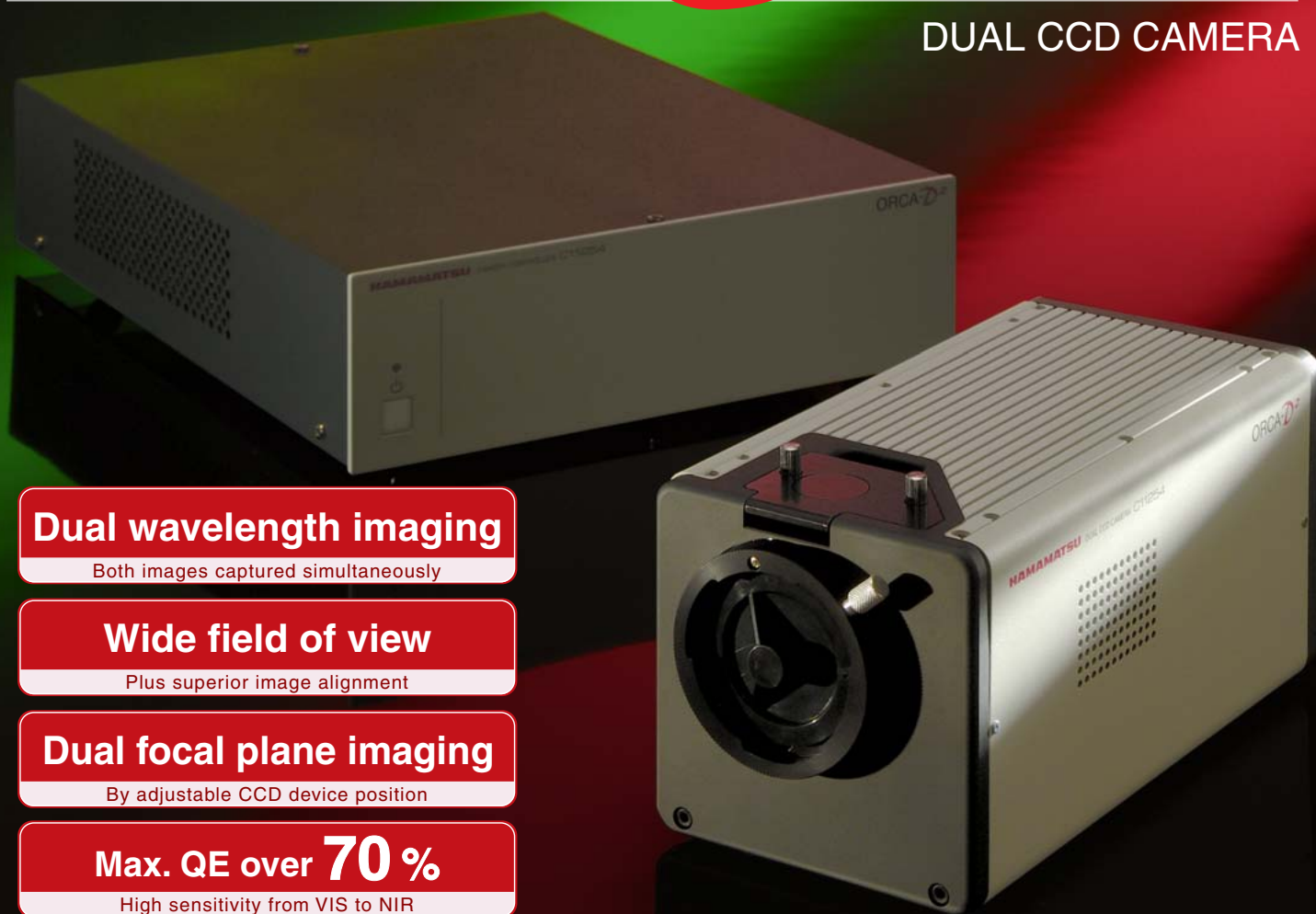

DUAL CCD CAMERA



## Dual wavelength imaging

Both images captured simultaneously

## Wide field of view

Plus superior image alignment

## Dual focal plane imaging

By adjustable CCD device position

## Max. QE over 70%

High sensitivity from VIS to NIR

## A One-of-a-kind Solution for Dual Wavelength Imaging

With the ORCA-D2, you can now capture dual wavelength images simultaneously, at wavelength ranges of your choice, and with a wide field of view – a unique combination that simplifies the challenges of conventional FRET and ratio imaging techniques. The ORCA-D2 contains two CCD devices. Interchangeable optical blocks are used to set the wavelength ranges for each CCD. During image capture, the camera automatically corrects focus, alignment and color shifting to produce high-quality images.

Other benefits of the ORCA-D2 include high sensitivity and low noise, courtesy of Hamamatsu's advanced CCD cooling technology; wide dynamic range; standard IEEE1394b interface; and Hamamatsu's proprietary vacuum-sealed chamber technology, which promotes long-term maintenance-free operation with even the most demanding applications.

### APPLICATIONS

- Ratio imaging
- Single and dual wavelength fluorescence microscopy, FRET
- Blue to NIR fluorescence applications
- Colocalization and FISH applications
- Dual wavelength TIRF microscopy, real-time confocal microscopy
- Combined transmission and fluorescence imaging
- Multi-focal point imaging microscopy

**HAMAMATSU**

# FEATURES

## Simultaneous capture of wide-field dual wavelength images

### Dual wavelength imaging

The unique camera design makes it possible to capture simultaneous dual wavelength images with a full field of view, even when the intensities differ significantly. Such images are difficult to obtain with conventional FRET or ratio imaging techniques.

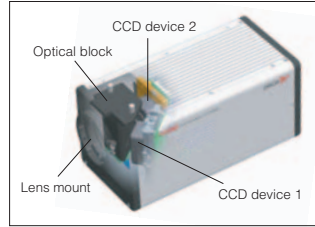

▲ Internal structure of camera head

### Selectable wavelengths

By changing optical blocks, you can select your wavelengths of interest. Hamamatsu offers three types of optical blocks for different wavelength ranges.



### Comparison with conventional methods

#### ORCA-D2

- ✓ Simultaneous capture at dual wavelengths
- ✓ Selectable wavelengths
- ✓ Auto-correction of color or image shifting
- ✓ Wide field of view

#### W-view optics

- ✓ Simultaneous capture at dual wavelengths
- ✓ Selectable wavelengths
- ✗ Steps required to correct color or image
- ✗ Reduced field of view

#### 3CCD color camera

- ✓ Simultaneous capture at dual wavelengths
- ✗ No selection of wavelengths
- ✗ No correction of color or image shifting
- ✓ Wide field of view

#### Filter wheel

- ✗ No simultaneous capture at dual wavelengths
- ✓ Selectable wavelengths
- ✗ No correction of color or image shifting
- ✓ Wide field of view

### Application example 1 $Ca^{2+}$ measurement using YellowCameleon 3.6 (optical block: DM 510 nm)

The following images are an example of ratio imaging. Separated CFP and YFP (FRET) are measured with dual CCD devices. This sequence observed the YellowCameleon 3.6 ( $Ca^{2+}$  sensor based on CFP-YFP FRET) expressed Ins-1 cell response with a depolarizing stimulus.

● CFP-channel (CCD1)

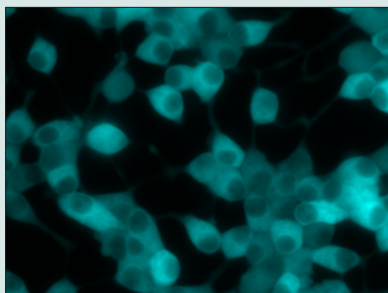

● YFP-channel (CCD2)

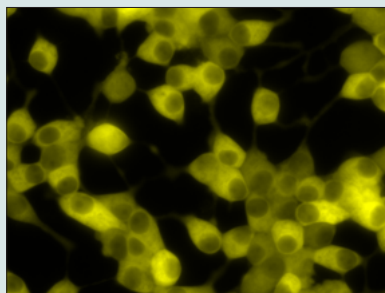

● Temporal change of brightness

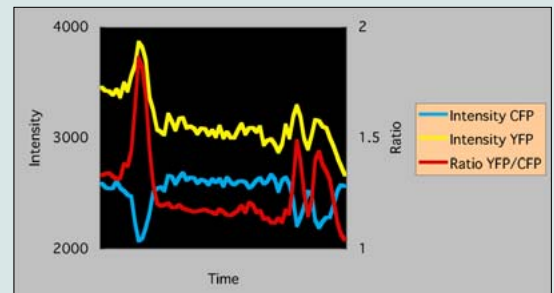

Samples courtesy of Hideo Mogami, Ph.D.  
 Dept. of Physiology, Hamamatsu University School of Medicine  
 Dept. of Environmental Biology, Okazaki Inst. for Integrative Bioscience

Sample: Ins-1 cell (insulin-producing cell)  
 ORCA-D2 optical block: A11400-03 (DM 510 nm, Em1 483 nm/32 nm, Em2 542 nm/27 nm)  
 Microscope: Olympus IX71  
 Objective lens: Olympus LUCPlanFLN 60x, NA 0.70

## Easy setup

### ● Auto-correction of focus and alignment

During dual wavelength image acquisition, the camera will automatically correct image alignment, color mismatch, etc. Hardware and special software work together to adjust focus\* and alignment to your experimental setup. Calibration results are saved in the software, eliminating the need to readjust for the same setup.

\*Please note that auto-correction may not be possible in some experimental setups.

#### Example of correction of focus and alignment

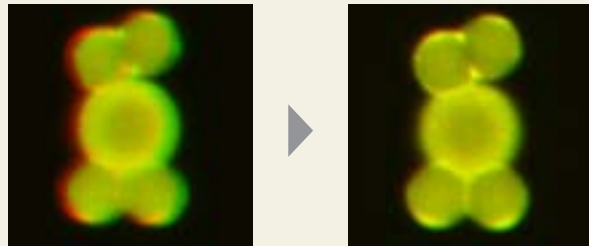

▲ Before

▲ After

Sample: Multi fluorescent beads (6.0  $\mu\text{m}$  to 7.9  $\mu\text{m}$ )

ORCA-D2 optical block: A11400-04 (DM 550 nm, Em1 520 nm/35 nm, Em2 593 nm/40 nm)

### ● Focus adjustment

Images with different focal plane can be acquired at the same time through the use of the camera's special software and adjustable CCD device position.

#### Pollen with a 10 $\mu\text{m}$ diameter

The following images are examples of using different focal plane imaging at the same time.

##### ● CCD1

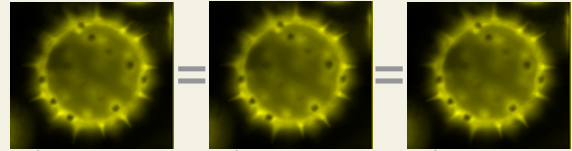

▲  $\pm 0 \mu\text{m}$

▲  $\pm 0 \mu\text{m}$

▲  $\pm 0 \mu\text{m}$

##### ● CCD2

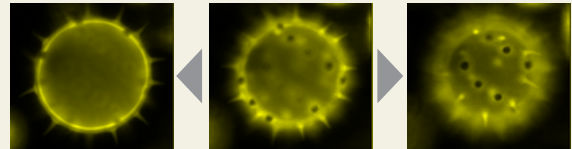

▲ +4  $\mu\text{m}$

▲  $\pm 0 \mu\text{m}$

▲ -4  $\mu\text{m}$

## High-sensitivity imaging from visible to near-infrared

### ● Dual light mode

Two modes (high light, low light) are available for different situations. Low light mode provides high sensitivity over a wide spectral range from visible to near-infrared.

### ● Max. quantum efficiency over 70 %

The ORCA-D2 offers high sensitivity from visible to near-infrared with its ER-150 interline CCD. In low light mode, sensitivity at 700 nm is nearly twice that of the ICX285\* device used in most other scientific CCD cameras.

\* ICX285 is a conventional high-sensitivity CCD device which is used for scientific instrumentation.

#### Spectral response

(This sample is typical of the CCD characteristics, not guaranteed.)

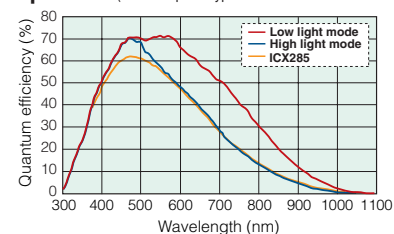

#### ■ ICX285\* image

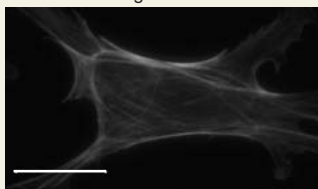

▼ Brightness profile of area marked with white horizontal line

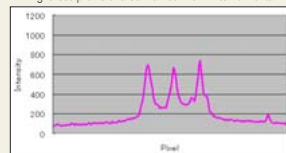

#### ■ Low light mode image (ORCA-D2)

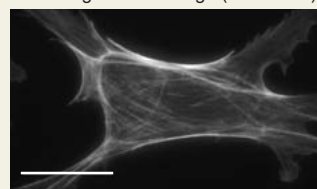

▼ Brightness profile of area marked with white horizontal line

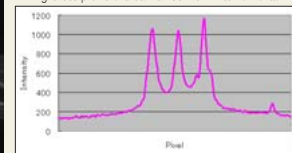

## Application example 2

### Ca<sup>2+</sup> and PKC dual imaging using Fluo-4 and DsRed (optical block: DM 550 nm)

The images below show fluorescence signal from Fluo-4 AM loaded cells expressing PKC-DsRed when excited by 480 nm light. Observable in this time sequence is the translocation of PKC-DsRed to the cell membrane concurrent with free Ca<sup>2+</sup> elevation in response to a depolarizing stimulus.

#### ● Fluo-4-channel (CCD1)

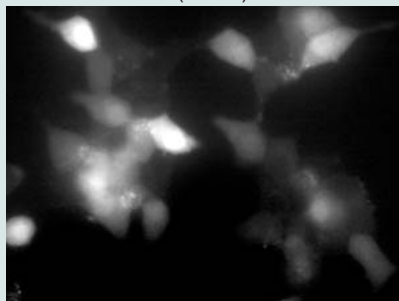

#### ● DsRed-channel (CCD2)

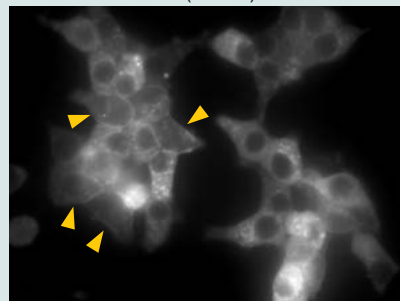

#### ● Superimposed images of Fluo-4 (CCD1) and DsRed (CCD2)

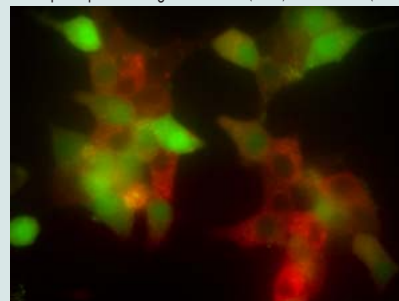

Images courtesy of Hideo Mogami, Ph.D.  
Dept. of Physiology, Hamamatsu University School of Medicine  
Dept. of Environmental Biology, Okazaki Inst. for Integrative Bioscience

Sample: Ins-1 cell (insulin-producing cell)  
ORCA-D2 optical block: A11400-04 (DM 550 nm, Em1 520 nm/35 nm, Em2 593 nm/40 nm)  
Microscope: Olympus IX71  
Objective lens: Olympus UPlanAPO 60x / 1.20 W

## SYSTEM CONFIGURATION

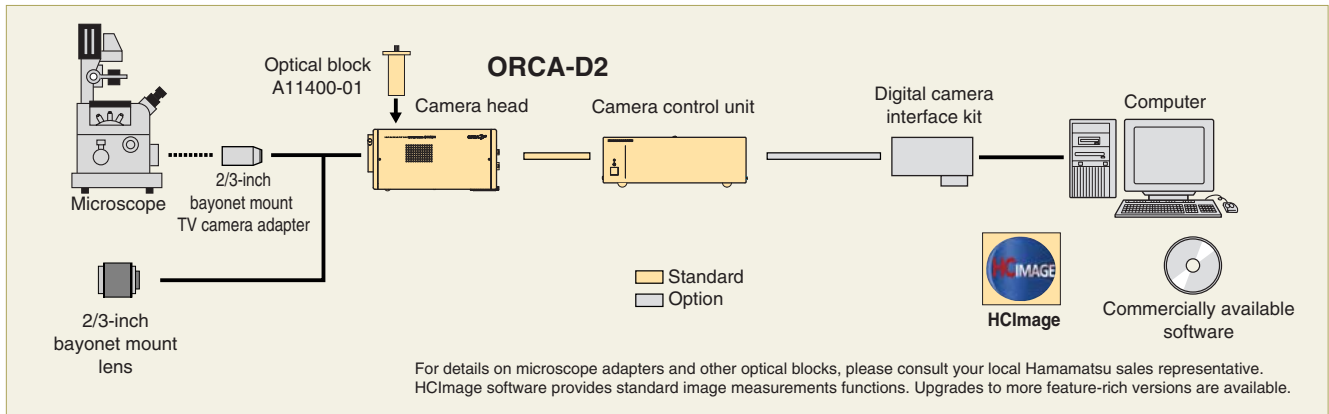

## SPECIFICATIONS

Type number	C11254-10B (ORCA-D2)		
Camera head type	Hermetic vacuum-sealed head		
Imaging device	ER-150 progressive scan interline CCD		
Effective number of pixels	1280 (H) × 960 (V) × 2CCD chip		
Cell size	6.45 μm (H) × 6.45 μm (V)		
Effective area	8.26 mm (H) × 6.19 mm (V)		
Pixel clock rate	20.00 MHz/pixel		
Readout speed	1 × 1	11.2 frames/s	
	Binning	2 × 2	20.2 frames/s
		4 × 4	33.6 frames/s
		8 × 8	50.5 frames/s
Readout noise (r.m.s.) typ.	8 electrons		
Full well capacity typ.	1 × 1	18000 electrons	
	Binning 2 × 2	36000 electrons	
Dynamic range typ. ①	2250 : 1 typ. (1 × 1)		
Cooling method	Peltier device + Forced-air cooled		
Cooling temperature	- 10 °C (Ambient temperature: + 20 °C)		
Dark current	0.01 electrons/pixel/s (- 10 °C)		
A/D converter	12 bit		
Exposure time	117 μs to 60 s		
Sub-array	Yes		
Contrast intensification	Analog gain (10 times max.), offset		
External trigger mode	Edge trigger, Level trigger, Synchronous readout trigger, Start trigger		
Trigger output	Programmable timing output, Trigger ready output		
Lens mount	2/3-inch bayonet mount (flange back focus 48 mm)		
Interface	IEEE1394b-2002		
External control	IIDC 1394-Based Digital Camera Specification Ver.1.32		
Power requirements	AC 100 V to AC 240 V, 50 Hz / 60 Hz		
Power consumption	Approx. 70 V·A		
Ambient storage temperature	- 10 °C to + 50 °C		
Ambient operating temperature	+ 10 °C to + 35 °C		
Ambient storage / operating humidity	70 % max. (no condensation)		

① Calculated from the ratio of the full well capacity and the readout noise

### ORCA is registered trademark of Hamamatsu Photonics K.K.

Product and software package names noted in this documentation are trademarks or registered trademarks of their respective manufacturers.

● Subject to local technical requirements and regulations, availability of products included in this promotional material may vary. Please consult your local sales representative.

● Information furnished by HAMAMATSU is believed to be reliable. However, no responsibility is assumed for possible inaccuracies or omissions. Specifications and external appearance are subject to change without notice.

© 2010 Hamamatsu Photonics K.K.

# HAMAMATSU

HAMAMATSU PHOTONICS K.K., Systems Division

812 Joko-cho, Higashi-ku, Hamamatsu City, 431-3196, Japan, Telephone: (81)53-431-0124, Fax: (81)53-433-8031, E-mail: export@sys.hpk.co.jp

U.S.A. and Canada: Hamamatsu Corporation: 360 Foothill Road, Bridgewater, N.J. 08807-0910, U.S.A., Telephone: (1) 908-231-0960, Fax: (1) 908-231-0852, E-mail: usa@hamamatsu.com

Germany: Hamamatsu Photonics Deutschland GmbH: Arzbergerstr. 10, D-82211 Herrsching am Ammersee, Germany, Telephone: (49)8152-375-0, Fax: (49)8152-2658, E-mail: info@hamamatsu.de

France: Hamamatsu Photonics France S.A.R.L.: 19, Rue du Saule Trapu, Parc du Moulin de Massy, 91882 Massy Cedex, France, Telephone: (33)1 69 53 71 00, Fax: (33)1 69 53 71 10, E-mail: info@hamamatsu.fr

United Kingdom: Hamamatsu Photonics UK Limited: 2 Howard Court, 10 Tewin Road, Welwyn Garden City, Hertfordshire, AL7 1BW, U.K., Telephone: (44) 1707-294888, Fax: (44) 1707-325777, E-mail: info@hamamatsu.co.uk

North Europe: Hamamatsu Photonics Norden AB: Smidesvägen 12, SE-171-41 Solna, Sweden, Telephone: (46)8-509-031-00, Fax: (46)8-509-031-01, E-mail: info@hamamatsu.se

Italy: Hamamatsu Photonics Italia S.R.L.: Strada della Moia, 1 int.6-20020 Arese (Milano), Italy, Telephone: (39)02-935 81 733, Fax: (39)02-935 81 741, E-mail: info@hamamatsu.it

### ● Optical blocks

Type number	Optical block			Applications
	Dichroic	Em1	Em2	
A11400-01	None	0 %	100 %	1CCD camera
A11400-02	Half	50 %	50 %	Beam splitter
A11400-03	510 nm	483 nm / 32 nm	542 nm / 27 nm	CFP / YFP
A11400-04	550 nm	520 nm / 35 nm	593 nm / 40 nm	FITC / TRITC
A11400-05	630 nm	593 nm / 40 nm	692 nm / 40 nm	Cy3 / Cy5
A11400-08	570 nm	520 nm / 35 nm	641 nm / 75 nm	GFP/mCherry

A11400-01 is included with camera. Other optical blocks are optional.

## DIMENSIONAL OUTLINES

(Unit: mm)

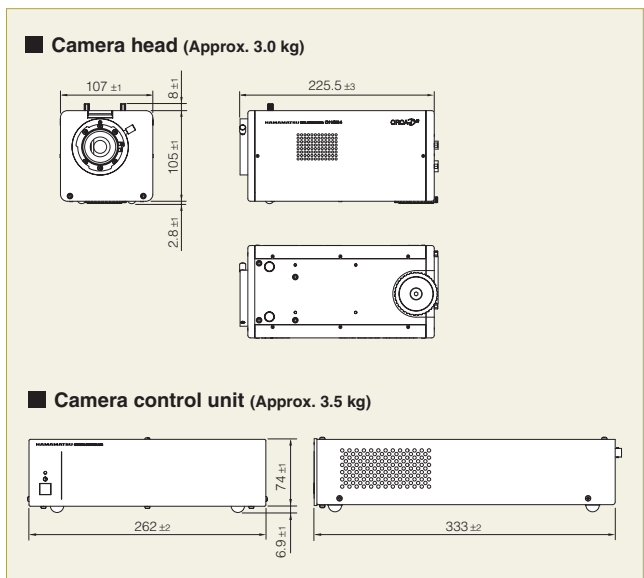

Homepage Address <http://www.hamamatsu.com>

Cat. No. SCAS0067E06  
JUL/2010 HPK  
Created in Japan